

Multipure®



Multipure Drinking Water Systems

Aquaversa OWNER'S MANUAL

For Model Nos. MP750SC, MP750SB, MP750SI and MP1200EL

Please retain this manual for future reference.

Multipure International • P.O. Box 34630 • Las Vegas, NV 89133-4630 •
Phone 702.360.8880 • Toll-Free 800.622.9206
www.multipure.com

Multipure Drinking Water Systems

Thank you for selecting a Multipure Drinking Water System to meet your need for quality drinking water. You have acquired one of the finest drinking water treatment devices available for the reduction of a wide array of contaminants. We are confident that your Multipure System will make a difference in your life. Thank you for your business.

Table of Contents

About	3
Before You Begin	3
Specifications	3
Below Sink Installation Overview and Part Numbers	4
Countertop Installation Overview and Part Numbers	5
1. Installation Preparation	
1.1: Installing the Filter Cartridge (Universal)	6
1.2: Locating the Appropriate Installation Instructions	7
2. Countertop Installation	
2.1: Connecting the Hose and Diverter Valve to the Faucet	7
2.2: Preparing and Operating Your Drinking Water System	8
3. Below Sink Installation	
3.1: Required Installation Tools	8
3.2: Installing the Faucet	9
3.2-a: Drilling the Faucet Hole	9
3.2-b: Installing the Standard Faucet	10
3.2-c: Installing the Capacity Monitor Faucet	11-13
3.3: Connecting to Your Plumbing	13-14
3.4: Connecting the Tubing to the Housing	15-16
3.5: Placing the System Under the Sink	17
3.6: Installing the System for Inline Use	17
3.7: Preparing and Operating Your Drinking Water System	18
4. Maintenance	
4.1: Regarding Filter Capacity	19
4.2: Removing the Old Filter	19
4.3: Installing the New Filter	19
4.4: Resetting the Capacity Monitor or Changing the Batteries	20
4.5: Flushing / Disinfecting the System	20
5. Additional Information	
5.1: Warranty	20
5.2: Performance Certifications	21
5.3: Performance Data Sheet	22-24
5.4: California Certification	25
5.5: Troubleshooting	26
5.6: Frequently Asked Questions	27

About the Aquaversa Drinking Water System

- The Multipure Aquaversa Drinking Water System (Model# MP750) is designed for use on the countertop next to the sink, below the sink, or inline with other devices. It can connect to the existing faucet or to the water source below the sink.
- The Aquaversa includes all the accessories and fittings required for installation (except for the MP750SI Inline unit).
- If installation or operation assistance is required, please contact your Multipure Independent Distributor. If the Independent Distributor is unavailable, please contact Multipure Customer Service at 800.622.9206.

Before You Begin

Multipure Drinking Water Systems (DWS) have been extensively tested and certified by NSF International to provide the highest level of assurance that the device will perform as claimed. Please read this manual before proceeding with the installation and use of your system. Installation, operation, and maintenance requirements are essential to the performance of your system – failure to follow any instructions or operating parameters contained herein may lead to product damage or product failure.

- Replacement filters can be purchased directly from Multipure. For the latest prices, please visit our website at <http://www.multipure.com/store/>.
- Actual filter life depends on the amount of water used and the level of impurities in the water. *See 4.1: Regarding Filter Capacity* for additional details.
- Multipure Drinking Water Systems are not intended for use with microbiologically unsafe water or non-municipally-treated water. Systems certified for cyst reduction may be used on disinfected waters that may contain filterable cysts. *See 5.5: Frequently Asked Questions* for additional details.
- Do not allow water to freeze in the system. If the system is exposed to freezing temperatures, drain water from the system and remove the filter. Allow the filter to thaw before replacing and reusing.
- Do not allow water to sit in the system for extended periods of time (i.e., 10 days or more) without use. *See 4.5: Flushing / Disinfecting the System* for additional details.
- To dispose of the used filter, remove it from the housing and place in normal refuse. Filters disposed in a normal landfill will not release any chemical contaminants and may continue to adsorb additional contaminants in the landfill.
- Check for compliance with any state or local laws and regulations before use.

Specifications

Specifications	
Model Name	Aquaversa (MP750, MP1200EL)
Approximate Filter Capacity	750 gallons
Approximate Filter Capacity with Capacity Monitor	1200 gallons
Replacement Filter Type	CB6
Approximate Flow Rate @60 psi	0.75 gpm
Housing Composition	Stainless Steel
Rubber Items	Nitrile (NBR)
Outlet	1/4" tube x 1/8" pipe
Inlet	1/4" tube x 1/8" pipe
Working Pressure Range	30 psi (2.1 kg/cm ²) to 100 psi (7.0 kg/cm ²)
Operating Temperature Range	32° F (0° C) to 100° F (38° C) – for cold water use only
Particle Retention Size	0.5 micron (sub-micron)
Certified By	NSF International

Below Sink Installation Overview & Part Numbers

Item #	Part #	Part Description	Item #	Part #	Part Description
1	MC652	Faucet assembly with blue tubing attached	8	MC253ASBL	V-band with knob
2	MC780	Wing nut	9	MC126	Bracket
3	MC720	Outlet adapter - connects to blue tubing attached to faucet	10	MC351	O-ring
4	MC720	Inlet adapter - connects to clear tubing	11	MCB500	Housing bottom
5	MCL500	Housing top	12	011-25-4100	Acrylic sleeve*
6	MC252-BLK	Black Rubber Cushion (inside housing top)	13	MC232RH	Clear tubing -connects inlet adapter to plumbing
7	CB6	Carbon Block Filter	14	MC920LF	Adapta Valve

Connect clear tubing to plumbing -- Option A or B

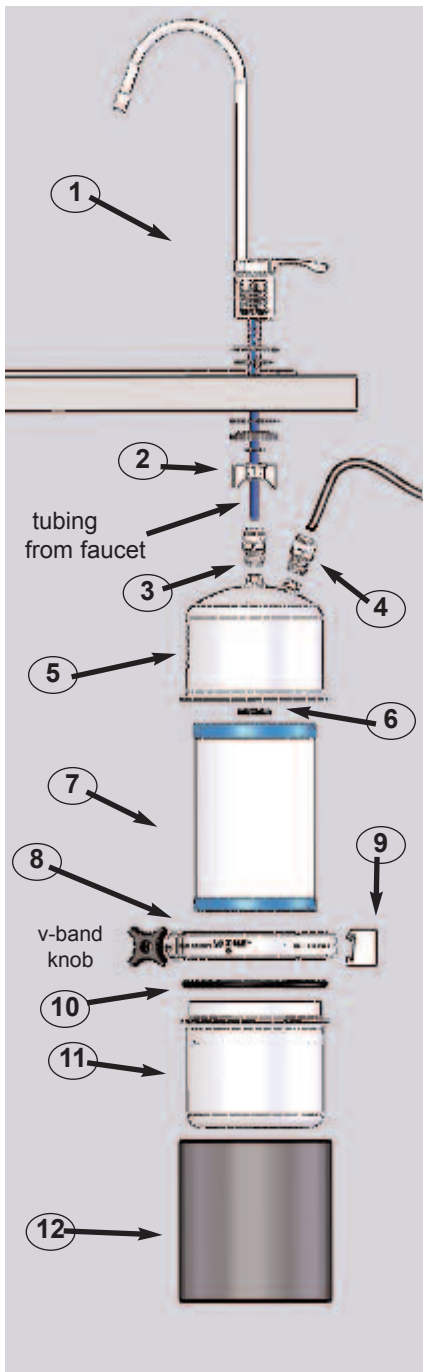

Note: the Aquaversa MP750SI Inline unit does not include the following parts: faucet assembly (#1), wing nut (#2), outlet adapter (#3), inlet adapter (#4), acrylic sleeve (#12), clear tubing (#13), adapta valve (#14)

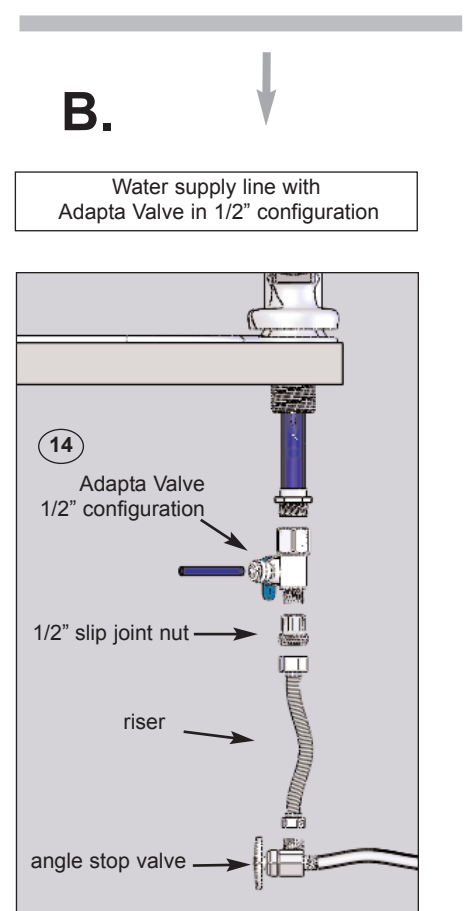
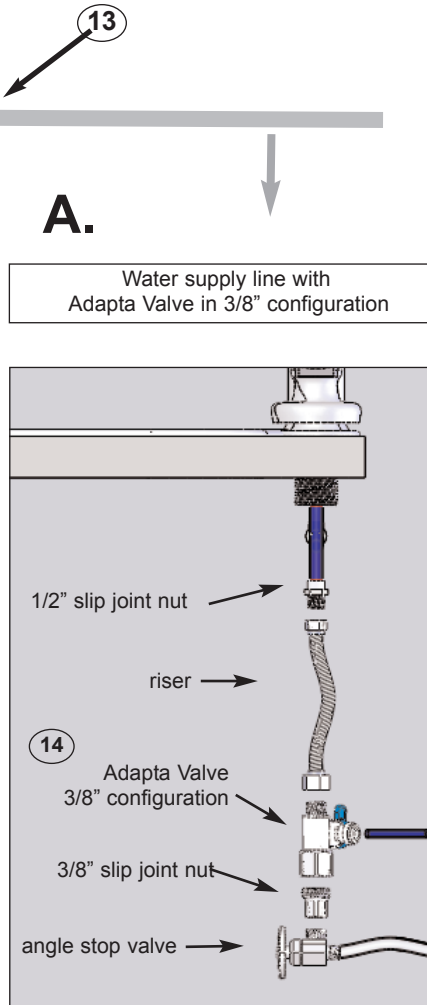

* The acrylic sleeve (Item#12) is an optional part available for purchase.

Countertop Installation Overview & Part Numbers

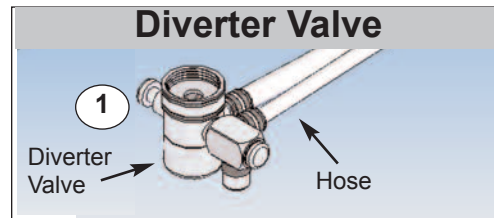
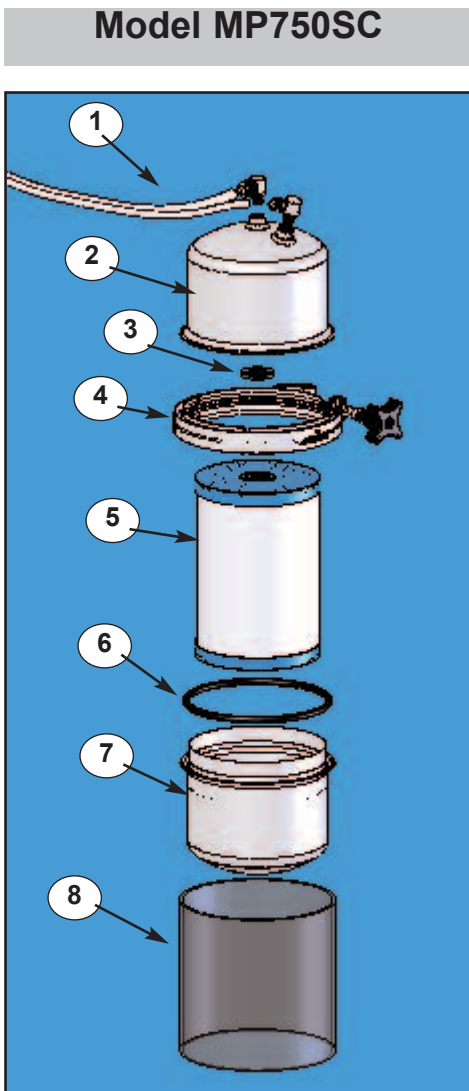

Part Numbers

- | | | |
|----|-------------|---|
| 1. | MC6400ASBL | Hose and Diverter Valve |
| 2. | MCL500 | Housing Top |
| 3. | MC252-BLK | Black Rubber Cushion (inside housing top) |
| 4. | MC253ASBL | Locking V-Band |
| 5. | CB6 | Filter Cartridge |
| 6. | MC351 | O-Ring |
| 7. | MCB500 | MP750 Housing Bottom |
| 8. | 011-25-4100 | Acrylic base |
| 9. | MC700 | Standard Adapters (see page 7*) |

1. INSTALLATION PREPARATION

Before beginning, inspect your DWS to confirm that it has been received in good condition and that all parts are included (refer to the specific installation section for the parts list). Perform the following instructions prior to system installation.

Should you require assistance, please contact your Independent Distributor; if she/he is not able to help you, please feel free to contact Multipure's Customer Service Department directly at 800.622.9206.



Model MP750SB

1.1: Installing the Filter Cartridge

1. **If you have not done so already, remove the plastic wrapper and instruction wrap from around the filter.**
2. With the DWS housing in an upright position, unscrew the black knob on the Locking V-Band by turning it counter-clockwise.
3. With the black knob removed, spread the Locking V-Band apart and lift up and off of the DWS. Carefully set it aside.
4. Lift the top half of the DWS off of the bottom half. Make sure that the black O-ring remains in place on the bottom half of the housing.
5. Align the threaded hole of the filter cartridge onto the inside thread of the top half of the DWS. Rotate the cartridge clockwise to tighten; the cartridge typically requires four to five revolutions to tighten adequately. Make sure that the cartridge is threaded properly and straight. **DO NOT OVERTIGHTEN.**
6. Reconnect the top half of the DWS (with attached filter cartridge) with the bottom half. Replace the Locking V-Band, making sure the screw is in place to connect the band together.
7. Screw the black knob onto the Locking V-Band, turning it clockwise to tighten.
8. Make sure that the Locking V-Band is secured tightly and evenly around the top and bottom halves of the DWS housing.

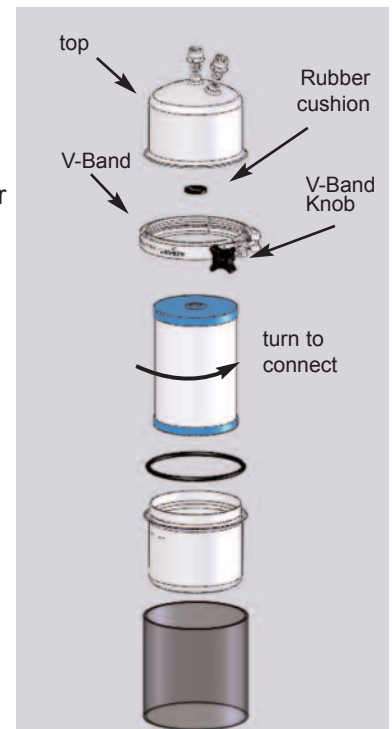

1.2: Locating the Appropriate Installation Instructions

1. Determine your installation type (e.g., countertop, below sink, inline).
2. Proceed to the instructions for your installation type:
 - a. For Countertop Installation, proceed to section 2. **Countertop Installation.**
 - b. For Below Sink Installation (with or without a capacity monitor), proceed to section 3. **Below Sink Installation.**
 - c. For Inline Installation, proceed to section 3.6: **Installing the System for Inline Use.**

2. Countertop Installation

When installing on a countertop, the Aquaversa sits atop its included acrylic base on the counter next to the sink. It connects to the existing faucet via a dual-hose diverter valve. Follow these instructions to connect the Aquaversa for countertop use.

2.1: Connecting the Hose and Diverter Valve to the Faucet

1. Remove the aerator or screen (if present) from the end of the faucet. If facing the open end of the spout, rotate the aerator counter-clockwise to loosen and remove.
2. Attach the diverter valve directly to the faucet spout. If the threads of the diverter valve do not match the threads of the faucet, use one of the included faucet adapters to connect the diverter valve and faucet. If facing the open end of the spout, rotate the diverter valve and/or adapter clockwise to tighten.



NOTE: When using a faucet adapter, the rubber washer in the adapter always faces up toward the faucet.

a. If Your Faucet Has an Outside Thread (male connector):

For many faucets with an outside thread, the diverter valve can attach directly to the faucet. If the diverter valve is too small to attach to the faucet, attach the inside thread (female connector) adapter, part# MC106, to the faucet, and then attach the diverter valve to the adapter.

b. If Your Faucet Has an Inside Thread (female connector):

The diverter valve cannot directly connect to a faucet with a female connector. Attach one of the outside thread (male connector) adapters, part# MC107 or part# MC108, to the faucet, and then attach the diverter valve to the adapter. MC107 is designed to fit larger faucets, and MC108 is designed to fit smaller faucets.

c. If Your Faucet Requires More Room for the Diverter Valve Connection:

Some faucets, particularly sprayer hose faucets, require additional room for the diverter valve connection. If this applies, attach the long adapter, part# MC257, to the opening of the faucet spout/sprayer, and then attach the diverter valve to the adapter. The DWS may need to be repositioned on the sink to allow enough room for sprayer faucet use.

d. If the Adapters Do Not Fit Your Faucet:

Although the adapters included with your DWS allow connections with many standard faucets, they do not cover every type of available faucet connection. If none of the adapters allow the diverter valve to connect to your faucet, please contact Multipure Customer Service at 1.800.622.9206, ext. 175, to request part# MC105, part# MC109, or part# MC719 as possible adapter solutions.

3. When connected properly, the hose from the diverter valve should lead toward the back of the faucet and sink.
4. The diverter valve features a bypass lever with a button on the left and right sides of the diverter valve. Press the left button to bypass the DWS and select the unfiltered water spout (larger opening). Turn on your faucet to let unfiltered water flow out of the diverter valve and to make sure that the diverter valve is properly connected.
5. Turn off the faucet.

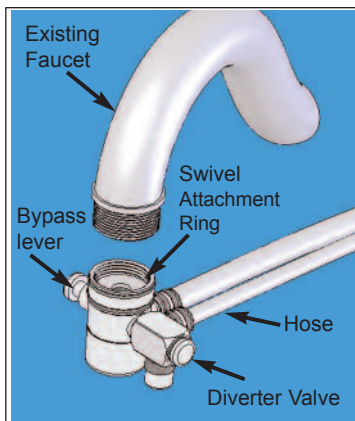

Diverter Valve Attachment

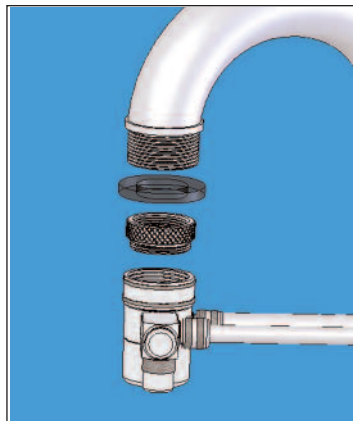

Diverter Valve Attachment with adapter

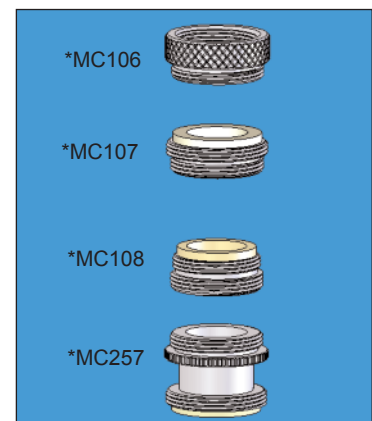

*MC700 - Adapters (choose one)
Many installations do not require an adapter

2.2: Preparing and Operating Your Drinking Water System

1. Using a paper towel or cloth, dry off all connections and the DWS housing.
2. Make sure that all connections are tightly secured.
3. Purge any air from the unit.
 - a. Press the right button on the diverter valve to select the filtered water spout. The water will flow through the DWS and emerge from the smaller opening on the diverter valve.
 - b. Allow water to flow through the DWS and filtered water spout for five minutes.
 - c. Press the left button to select the unfiltered water spout, and then turn off the faucet.
4. Make sure that all connections are tightly secured and that there are no leaks.
5. Turn on the faucet and press the right button to select the filtered water spout.
6. Allow water to flow through the DWS and filtered water spout for approximately **30 minutes**. This will flush the filter prior to use.
7. Press the left button to select the unfiltered water spout.
8. Turn off the faucet.
9. Check all connections to make sure that there are no leaks.
10. The system is now ready for use.

bypass
lever

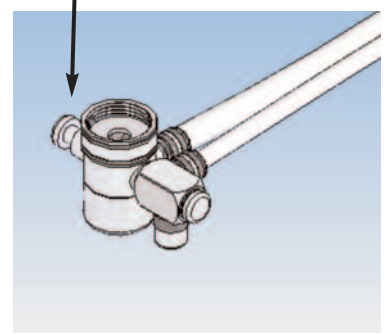

3. Below Sink Installation

The Aquaversa models MP750SB and MP1200EL are designed for use below the sink and can be installed on the incoming cold water line. The MP750SB and MP1200EL systems are connected to a specially designed faucet which installs directly on the sink.

3.1: Required Installation Tools

The following tools are required to install your Aquaversa for below-sink use:

1. Installing the faucet on a ceramic/porcelain sink:
 - a. 3/8" reversible electric drill
 - b. 7/16" (or 1/2") high speed steel drill bit
 - c. 1/2" carbide-tipped masonry drill bit
 - d. hammer
 - e. center punch
 - f. 8" adjustable wrench
 - g. pliers/locking pliers
2. Installing the faucet on a stainless steel sink:
 - a. everything from list #1, plus 1/8" high speed drill bit
3. Installing the Adapta Valve:
 - a. 8" adjustable wrench
 - b. wire cutter or knife



Model MP750SB

3.2: Installing the Faucet

The Aquaversa faucet can be installed through a standard faucet hole or spray hose hole in your sink, if one is available. If no hole is available, refer to section **3.2-a: Drilling the Faucet Hole**. Note that there are separate sections for installing a faucet with or without a capacity monitor.

Proceed to the instructions for your installation type:

1. For a standard faucet, proceed to section **3.2-b: Installing the Standard Faucet**.
2. For a capacity-monitored faucet, proceed to section **3.2-c: Installing the Capacity Monitor Faucet**.



3.2-a: Drilling the Faucet Hole

1. Select and mark the faucet mounting spot on the sink.
 - a. Confirm that there are no reinforcing ribs under the desired faucet location.
 - b. If you have an extra hole in your sink for a spray hose, you may also choose to disconnect the spray hose and use that existing hole for the DWS faucet.
2. Use the hammer to gently tap the center punch on the sink location where the hole is to be drilled. This creates an indentation marking the location to drill.

If You Have a Porcelain, Ceramic, or Cast Acrylic Sink:

CAUTION: Porcelain, ceramic, and cast acrylic surface materials are extremely hard and can crack or chip quite easily. Use extreme caution when drilling. Multipure is not responsible for any damages resulting from faucet installation.

NOTE: If you are installing a capacity monitor, you **MUST** use the 1/2" high-speed steel drill bit for step 2.

1. Use the 1/2" carbide-tipped masonry drill bit to grind away the porcelain down to the metal, clearing away enough porcelain to allow drilling without damaging the porcelain surface.
2. Carefully use the 7/16" (or 1/2") high-speed steel drill bit to completely drill a hole through the metal sink. **CAUTION:** Do not allow the drill bit to "grab" the porcelain, as this will damage the surface.

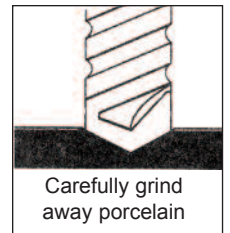
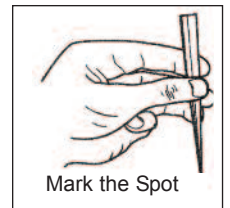

If You Have a Stainless Steel or Metal Sink:

NOTE: If you are installing a capacity monitor, you **MUST** use the 1/2" high-speed steel drill bit for step 2.

1. Use the 1/8" high-speed drill bit to drill a pilot hole.
2. Use the 7/16" (or 1/2") high-speed steel drill bit to completely drill a hole through the metal sink.

Note: For drilling a hole in your countertop, please consult with the countertop manufacturer.

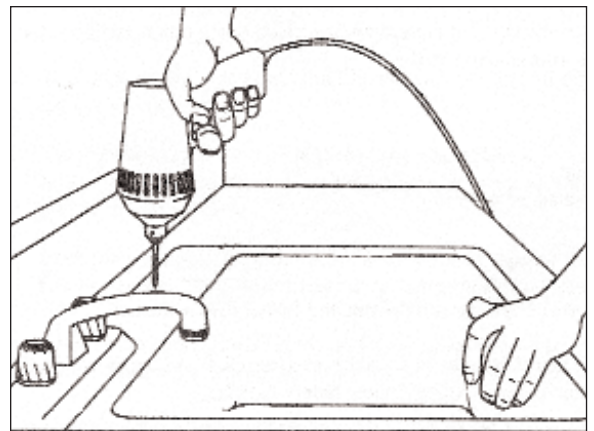

3.2-b: Installing the Standard Faucet



Complete Faucet Assembly
with Blue Tubing
MC652

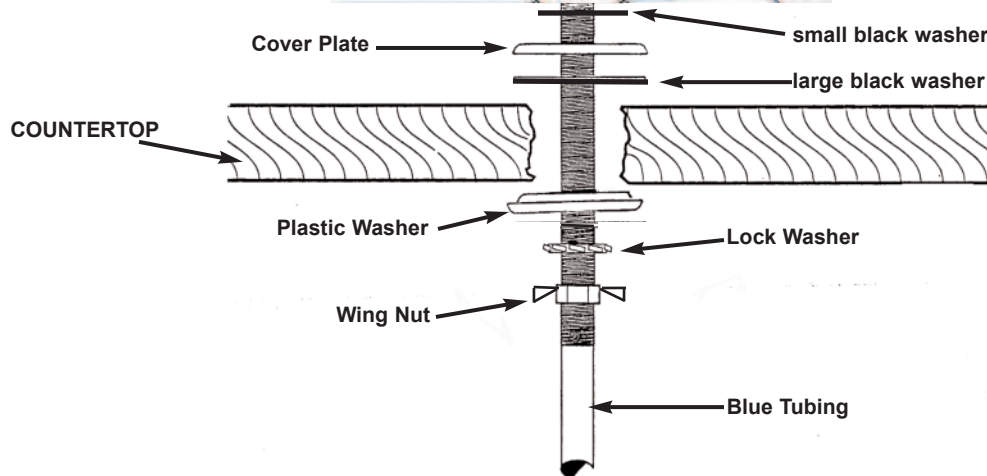

NOTE: The blue plastic tubing is attached to the faucet.

1. From the sink / countertop:

- Place the larger soft black rubber washer over the faucet hole.
- Place the cover plate on top of the large washer.
- Place the smaller soft black rubber washer on top of the cover plate.
- Place the faucet base over the smaller soft black rubber washer and atop the cover plate.

2. From under the sink:

- Slide the hard plastic black washer (with the smaller side up) upward over the blue tubing.
- Slide the lock washer upward, below the hard plastic washer.
- Slide the wing nut upward, below the lock washer.
- Hand-tighten the wing nut to secure the faucet.



3.2-c: Installing the Capacity Monitor Faucet

When the Aquaversa is installed with a capacity monitor, the DigiFlow 5000V Capacity Monitor (MC993) flashes red when the filter should be changed. Two AAA batteries (not included) are required for capacity monitor operation. The Capacity Monitor consists of two main parts, the LED Display Plate that sits below the faucet, and the Filter Monitor Unit (FMU) that connects in-line between the drinking water system housing and the faucet.

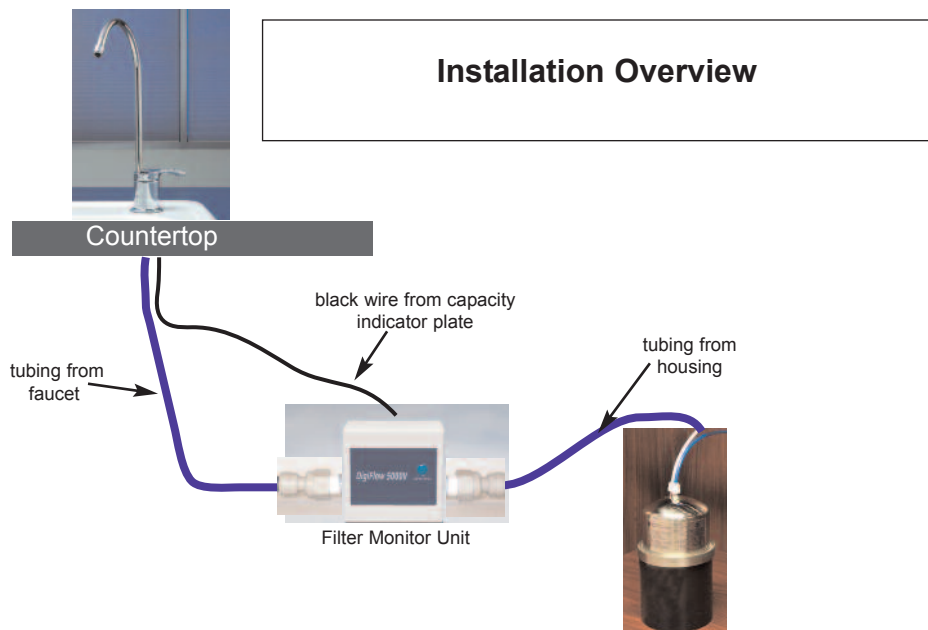

Faucets with Capacity Monitor include:

- 1 spout
- 2 faucet handle
- 3 faucet base
- 4 faucet stud
- 5 tubing (blue) attached to faucet
- 6 smaller rubber washer
- 7 LED display plate
- 8 black wire (attached to #7)
- 9 larger rubber washer
- 10 black track washer
- 11 hard plastic black washer
- 12 lock washer
- 13 wing nut
- 14 filter monitor unit
- 15 two adapters (MC744)

NOTE: In addition to the blue plastic tubing attached to the faucet. A separate piece of blue tubing is included for connection between the housing OUTLET port and the Filter Monitor Unit.

1. From the sink / countertop:
 - a. Place the LED Display Plate (#7) over the faucet hole.
 - b. Feed the attached black wire (#8) down through the faucet hole. Rotate the LED Display Plate so that the indicator light will be easy to see.
 - c. Place the faucet base (#3) on top of the LED Display Plate. Feed the blue tubing and faucet stud down through the hole in the sink. The faucet stud should now be accessible below the sink.
2. From under the sink:
 - a. Slide the black track washer (#10) (with the flat side down) upward over the threaded faucet stud. Guide the black wire (#8) from the LED Display Plate through the track to protect the wire and prevent it from becoming pinched between the sink and the stud nut.
 - b. Slide the hard plastic black washer (#11) upward over the blue tubing (#5), and faucet stud (#4).
 - c. Slide the lock washer (#12) upward over the faucet stud, below the black plastic washer.
 - d. Screw on the stud wing nut (#13) below the lock washer.
 - e. Hand-tighten the wing nut to secure the faucet.

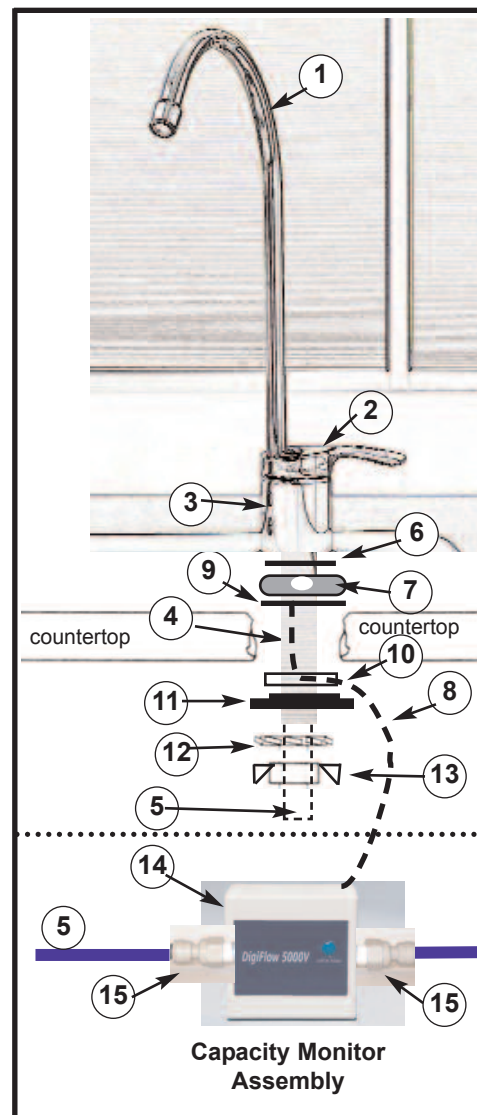

3.2-c: Installing the Capacity Monitor Faucet (continued)

Connect the Tubing to the Filter Monitor Unit

NOTE: Complete this step only after the DWS tubing has been connected in section 3.4: **Connect the Tubing to the Housing.**

1. Connect the two tube fittings (#15) (MC744) to the Filter Monitor Unit (#14) (FMU) by threading them into the threaded ports, one on each side (tighten securely, but do not over-tighten).
2. The FMU can be mounted either horizontally or vertically, but vertical installation is recommended. NOTE: The FMU will function with water flow in either direction.
3. Fully insert the blue plastic tubing (#5) from the DWS OUTLET into one side of the FMU.
4. Fully insert the blue plastic tubing (#5) from the faucet into the other side of the FMU.

NOTE: When pushing the tubing into the fitting, you will encounter some resistance. This does not mean that the tube is fully inserted. Continue to push firmly until the tubing is inserted as far as possible (roughly 5/8" into the fitting).

Insert blue tubing 5/8"

Set up the Filter Monitor Unit

1. Connect the black wire (#8) from the LED Display Plate into the Filter Monitor Unit (#14).
2. Open the top of the FMU and insert two (2) AAA batteries (not included) into the battery compartment, making sure to match the + and - signs. Close the battery compartment.
3. There will be a long audio sound, and the LED will blink green for two seconds, and then blink green five times.
4. After installing the batteries, press the check/reset button to confirm the LED is functioning.
5. Press and hold the check/reset button on the Filter Monitor Unit (FMU) for three (3) seconds. You should hear a long audible sound.
6. The LED on the LED Display Plate will blink green for one (1) second with an audible sound, then blink green and red for one (1) second each, and then blink green five (5) times twice. The remaining capacity and time is now reset to the original capacity.
7. Peel off the paper backing from the hook-and-loop connector strip, and attach one piece to the back of the FMU. Peel off the paper backing from the second hook-and-loop connector strip and attach it to the desired wall location. Attach the FMU to the wall using the two hook-and-loop connector strips.

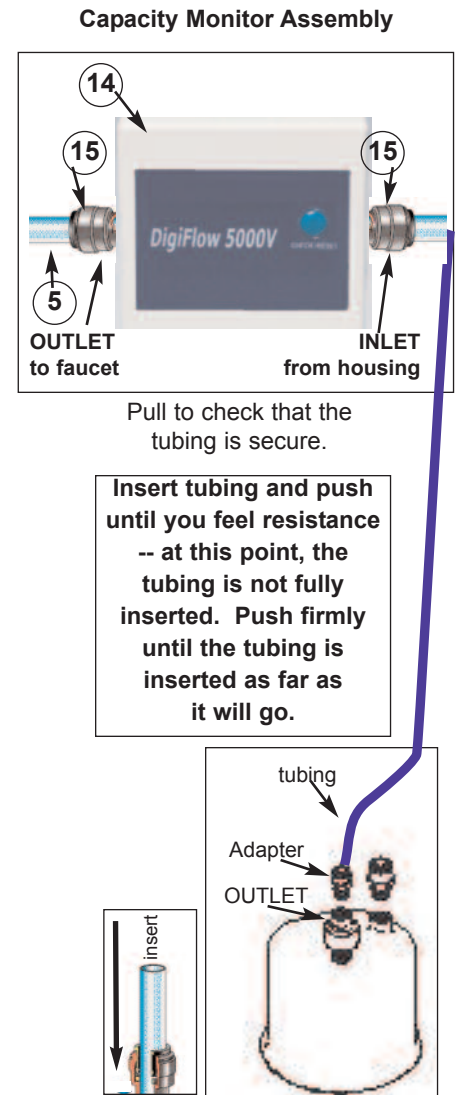

3.2-c: Installing the Capacity Monitor Faucet (continued)

Reading the LED Display Plate

1. When you turn on the faucet, or when the button on the FMU is pressed, the LED on the LED Display Plate blinks five (5) times to indicate the filter capacity status. The color of the LED indicates the filter status:
 - a. Green = 30% - 100% filter capacity
 - b. Orange = 0% - 30% filter capacity
 - c. Red = 0% filter capacity (the FMU will also play a long audible sound to indicate 0% capacity)
2. Multipure recommends ordering a new replacement filter (either online at <http://www.multipure.com/store/page6.html> or by telephone at 800.622.9206) when the monitor indicates 30% capacity or less.
3. The FMU will memorize the last remaining capacity in the event that the batteries lose power. It will restore the last remaining capacity when new batteries are installed.



NOTE: As with all drinking water treatment devices which reduce certain contaminants by mechanical filtration, the capacity of the filter can vary, and is dependent upon the type and level of contaminants in your water. If the system is used on water with high levels of particulate matter, Multipure recommends the installation and use of an additional pre-filter element.

3.3: Connecting to Your Plumbing

Included with your MP750SB/MP1200EL Drinking Water System is one installation kit, which includes all of the fixtures and accessories needed to install your system below the sink. If you determine that your particular plumbing configuration requires fixtures different from those included with your shipment, please contact Multipure's Customer Service office at 800.622.9206, ext. 175.

Determine Your Adapta Valve Configuration

If your residence has a cold water supply line with a 3/8" or 1/2" slip joint connection, you may use the Adapta Valve included with your system to connect your DWS to the plumbing. The Adapta Valve assembly (MC922ASBL) includes both the valve and threading adapter.

Adapta Valve
(#14)

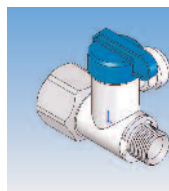

Threading adapter

NOTE: When attaching the Adapta Valve to straight pipe threads, use Teflon tape on the threads. Wrap the tape around the pipe only once.

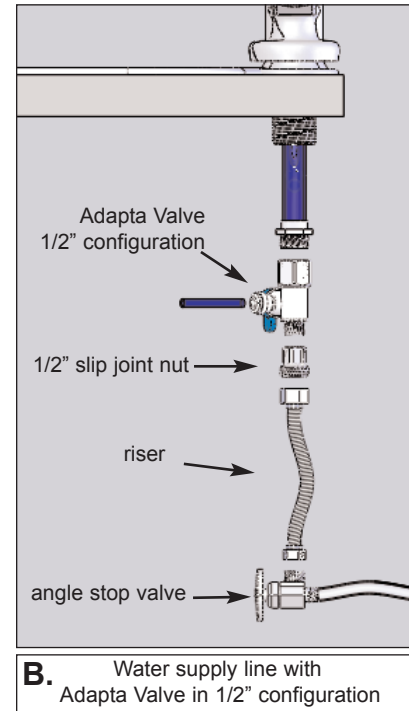
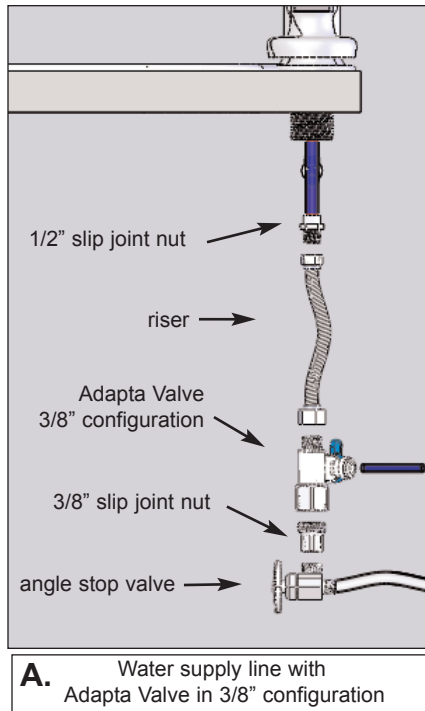
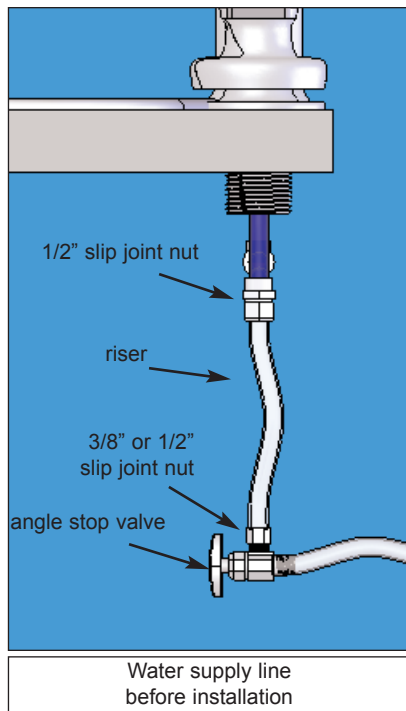

Adapta Valve Installation (continued)

1. Using the 3/8" configuration:

- The 3/8" configuration is used on a water supply line with a 3/8" slip joint.
- The 3/8" configuration is typically installed at the bottom of the riser at the angle stop valve.

2. Using the 1/2" configuration:

- The 1/2" configuration can be used at either the top of the riser at the faucet pipe or at the bottom of the riser at the angle stop valve.
- Install the 1/2" configuration at the top of the riser on a water supply line that does not have a slip joint nut at the angle stop valve.
- Install the 1/2" configuration at the angle stop valve if there is a 1/2" slip joint nut there.



3/8"
configuration



1/2"
configuration

Install the Adapta Valve

NOTE: The Adapta Valve must be installed on the **cold water line only**.

- Shut off the cold water supply to the faucet by rotating the angle stop valve clockwise until the water flow is off. Place a catch basin or other container below the faucet to catch any residual water in the pipes.
- Disconnect the cold water riser/supply line at the angle stop valve or cold water faucet pipe. Use an 8" adjustable wrench to rotate the slip joint nut counterclockwise until the riser/supply line and slip joint nut detach from either the angle stop valve or the faucet pipe.
- Connect the Adapta Valve to the pipe from which you removed the slip joint nut.
 - Align the Adapta Valve to either the angle stop valve or cold water faucet pipe, making sure that the rubber washer is in place in the Adapta Valve.
 - Use an 8" adjustable wrench to rotate the connection clockwise until tight. **DO NOT OVERTIGHTEN.**
- Connect the cold water riser/supply line with the slip joint nut to the Adapta Valve.
 - Align the slip joint nut to the Adapta Valve.
 - Use an 8" adjustable wrench to rotate the slip joint nut clockwise until tight. **DO NOT OVERTIGHTEN.**
 - Make sure that the supply line does not block the shutoff valve on the side of the Adapta Valve. If necessary, trim the supply line before reconnecting.
- Connect the 1/4" clear plastic tubing (included with the system) to the Adapta Valve.
 - Using wire cutters or a knife, cut (square cut) the tip end off of the clear plastic tubing. Do not use scissors.
 - Insert the tubing fully into the opening of the shutoff valve on the side of the Adapta Valve; the tubing should typically be inserted 5/8" into the adapter.



Insert clear tubing 5/8"

NOTE: When pushing the tubing into the opening, you will encounter some resistance. This does not mean that the tube is fully inserted. Continue to push firmly until the tubing is inserted as far as possible (roughly 5/8" into the adapter).

Push the tubing into the small hole as far as it will go. Pull to check secure.

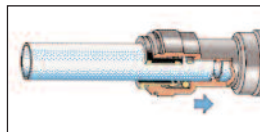

- Confirm that the Unit Shutoff Valve attached to the Adapta Valve is in the OFF position by rotating the handle clockwise until it stops.
- Proceed to section **3.4: Connecting the Tubing to the Housing** to connect the clear plastic tubing to the DWS.

3.4: Connecting the Tubing to the Housing

Attach the Adapters to the Housing

1. Connect the included Inlet adapter (MC720) to the system housing's labeled Inlet port. Rotate the adapter clockwise, first by hand, then using a wrench, to tighten onto the system.
2. Connect the included Outlet adapter (MC720) to the system housing's labeled Outlet port. Rotate the adapter clockwise, first by hand, then using a wrench, to tighten onto the system.

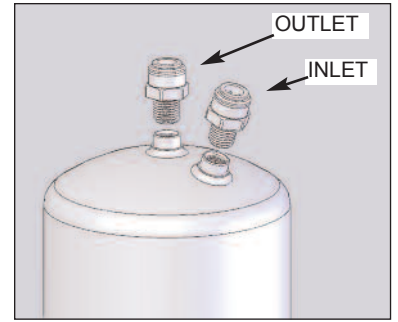

Housing Top

Connect the Tubing to the Outlet Port

1. Using wire cutters or a knife, cut (square cut) the tip end off of the blue plastic tubing (either connected to the faucet or a separate piece included with the Capacity Monitor). Do not use scissors.
2. Fully insert the tubing into the adapter on the OUTLET port of the system housing; the tubing should typically be inserted 5/8" into the adapter.

NOTE: When pushing the tubing into the adapter, you will encounter some resistance. This does not mean that the tube is fully inserted. Continue to push firmly until the tubing is inserted as far as possible (roughly 5/8" into the adapter).

Insert blue tubing 5/8"

3. Pull on the tubing to make sure that it is securely connected.

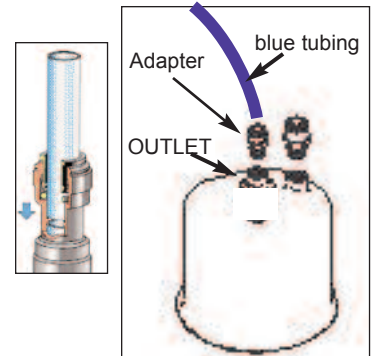

Insert tubing and push until you feel resistance -- at this point, the tubing is **not** fully inserted. Push firmly until the tubing is inserted as far as it will go.

Connect the Tubing to the Inlet Port

1. Using wire cutters or a knife, cut (square cut) the tip end off of the clear plastic tubing connected to the Adapta Valve. Do not use scissors. Do not cut more than 1/2" off of the end of the clear plastic tubing.
2. Fully insert the tubing into the adapter on the INLET port of the system housing; the tubing should typically be inserted 5/8" into the adapter.

NOTE: When pushing the tubing into the adapter, you will encounter some resistance. This does not mean that the tube is fully inserted. Continue to push firmly until the tubing is inserted as far as possible (roughly 5/8" into the adapter).

3. Pull on the tubing to make sure that it is securely connected.

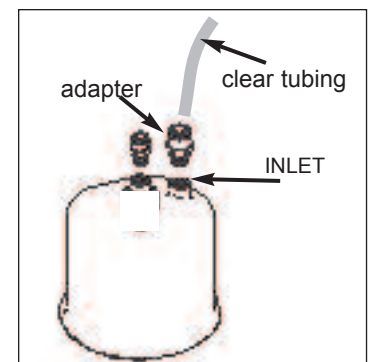

Connecting to Straight Adapter

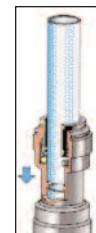

Insert tubing and push until you feel resistance -- at this point, the tubing is **not** fully inserted. Push firmly until the tubing is inserted as far as it will go.

Connecting to an Icemaker, Instant Hot Dispenser, or Other Device

Use the following steps to connect the DWS to an icemaker, instant hot dispenser, or other device in addition to your faucet or capacity monitor faucet. A TEE adapter (MC445) is required.

NOTE: To connect your DWS to the icemaker, instant hot dispenser, other device, you must have access to this other device from your sink.

1. Using wire cutters or a knife, cut (square cut) the blue plastic tubing 6" from where it is connected to the OUTLET port of the DWS housing. Do not use scissors.
2. Fully insert the blue plastic tubing from the DWS OUTLET into the bottom port of the Tee adapter. Push the tubing until you feel resistance, and then continue to push firmly until it is inserted as far as it will go.
3. Fully insert the blue plastic tubing from the faucet (or the tubing from the capacity monitor) into the top port of the Tee. Push the tubing until you feel resistance, and then continue to push firmly until the tubing is inserted as far as it will go.
4. Fully insert a separate 1/4" poly tube (available through Multipure or a plumbing supplier) into the side port of the Tee. Provide sufficient tubing to reach your icemaker, instant hot dispenser, and connect to that device.

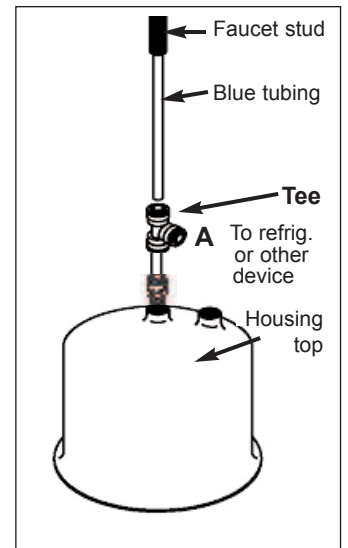
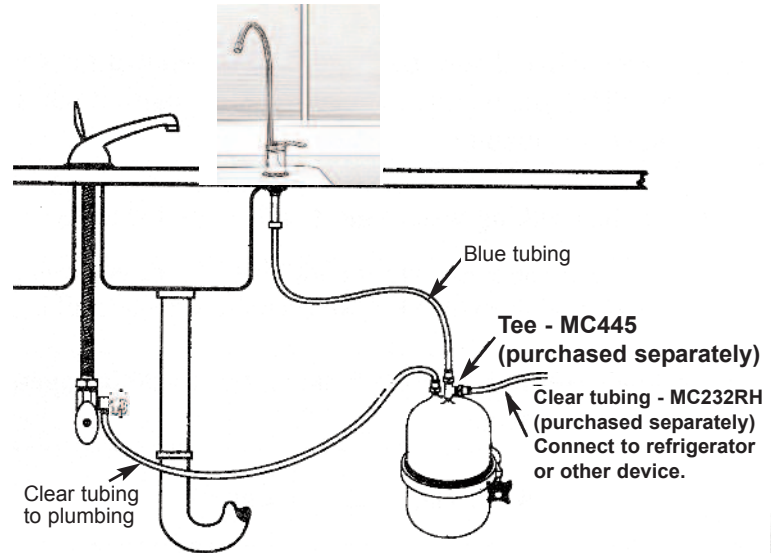

Unit with Stainless Steel Faucet

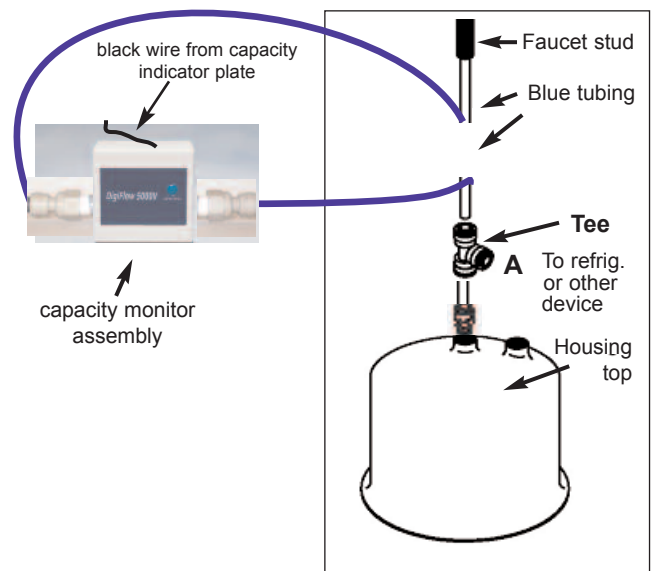

Unit with Capacity Monitor Faucet

3.5: Placing the System Under the Sink

The Aquaversa models MP750SB and MP1200EL are designed to mount to the cabinet wall beneath the sink. These systems can also sit on the cabinet floor with the use of an optional acrylic base. If you would like to order the Aquaversa acrylic base, please contact Multipure Customer Service at 800.622.9206, ext. 175.

1. Fasten the included mounting bracket to the wall, ensuring it is in an upright position. The bracket is in an upright position when the two holes on the bracket are at the top.
2. Attach the system to the bracket:
 - a. Tilt the system toward the wall.
 - b. Slide the V-Band that runs along the center circumference of the system up and into the upper notch on the bracket.
 - c. Straighten the system upright and let the bottom of the V-Band settle into the lower notch on the bracket.
3. To remove the system for servicing, reverse the previous steps.

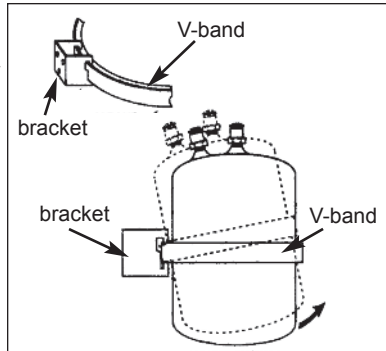

MP750SB

The MP750SB, MP750SI and MP1200EL units can also be placed "upside-down" in the acrylic sleeve. A notch has been cut out of the sleeve to accommodate the tubing. In this configuration, it may be necessary to relieve air which builds up in the stainless steel housing every two months.

To relieve the built-up air:

1. Turn on the faucet connected to drinking water system.
2. With the faucet in the "on" position, and water flowing through it, pick up the stainless steel housing and turn it "right side-up", so that the ports and tubing are now on top. You'll hear a "whooshing" sound come from the faucet as the trapped air escapes through the open faucet. This should only take a few moments.
3. Once water continues to flow out of the faucet, return the housing back to its "upside-down" position and turn off the faucet.



3.6: Installing the System for Inline Use

Multipure inline systems are ideal for refrigerators, water coolers, or restaurants where all water to a cold water outlet or faucet is filtered. The inline Aquaversa (MP750SI) includes the housing, filter, bracket, and screws. The inline models are appropriate for an inline installation and can be used with your existing faucet. Multipure recommends that a professional plumber install the system for inline use.



MP750SI

3.7: Preparing and Operating Your Drinking Water System

1. Using a paper towel or cloth, dry off all connections and the DWS housing.
2. Make sure that all connections are tightly secured.
3. Turn the water supply back on; rotate both the Adapta Valve shutoff valve and either the water supply Angle Stop Valve or water shutoff valve counter-clockwise to engage the flow of water through the pipes.
4. Turn the handle on the DWS faucet to start the flow of filtered water.
5. Allow water to flow through the DWS and the faucet for five minutes. This purges any air and loose carbon from the system.
6. Adjust the Angle Stop Valve or water shutoff valve so that the water flow to the drinking water faucet does not exceed the flow rate. NOTE: It takes approximately 20 seconds to fill a quart at 0.75 gallons per minute flow rate.
7. Turn off the DWS faucet and check for leaks.
 - a. Check the V-Band to confirm that it is secured evenly around the top and bottom housing halves.
 - b. Hand-tighten the black knob on the V-Band until it is as tight as possible.
8. Turn on the DWS faucet and allow water to flow for approximately **30 minutes**. This will flush the filter and charge the carbon.
9. Turn off the DWS faucet.
10. Check all connections to make sure that there are no leaks.
11. Congratulations! Your DWS is now ready for use.



If you have any questions regarding the installation of your Multipure Drinking Water System, call:

**Multipure International
Customer Service Department
7251 Cathedral Rock Drive
Las Vegas, NV 89128
702.360.8880 phone
800.622.9206 toll-free
702.360.8575 fax
email: custsvc@multipure.com
www.multipure.com**

4. Maintenance

4.1: Regarding Filter Capacity

1. Exact filter capacity varies in proportion to the amount of water used and the level of impurities in the water being processed. For contaminants reduced through physiochemical adsorption, the filter capacity is 750 gallons. For contaminants reduced through mechanical filtration, capacity claims are inapplicable due to broad variations in the quality and quantity of physical matter in the drinking water. Excessive physical matter will cause the DWS to clog, diminishing flow rate but reducing the contaminants from the resultant water stream.
2. For optimum performance and to maintain the lifetime warranty on your system housing, it is essential that the filter be replaced when the first of the following occurs: 1. annually, 2. when the system reaches its rated capacity, 3. when the flow rate diminishes, or 4. when the filter becomes saturated with bad tastes and/or odors.

4.2: Removing the Old Filter

1. Before opening the DWS housing, place a pan or basin beneath the housing.
2. Disengage the water supply to the DWS by turning the Adapta Valve shutoff valve clockwise or by turning the water supply shutoff valve clockwise.
3. Turn on the DWS faucet to relieve the water pressure in the system.
4. If the system is mounted on a bracket, remove the system from the bracket.
 - a. Tilt the top of the system toward the wall.
 - b. Slide the locking V-Band up and into the upper bracket notch.
 - c. Slide the system out of the bracket.
5. With the DWS housing in an upright position, unscrew the black knob on the Locking V-Band by turning it counter-clockwise.
6. With the black knob removed, spread the Locking V-Band apart and let it drop off the bottom of the DWS. Carefully set it aside.
7. Lift the top half of the DWS off of the bottom half. Make sure that the black O-ring remains in place on the bottom half of the housing.
8. Remove the old filter cartridge from the top half of the housing by rotating it counter-clockwise (if facing the inside of the top half of the housing).
9. Dispose of the used filter in your waste container.
10. Rinse out the inside of the system housing, hand washing if necessary.
11. Inspect the black rubber cushion on the inside of the top half of the housing, making sure that it is not cracked or worn; Multipure recommends that the cushion be replaced every two to three years.

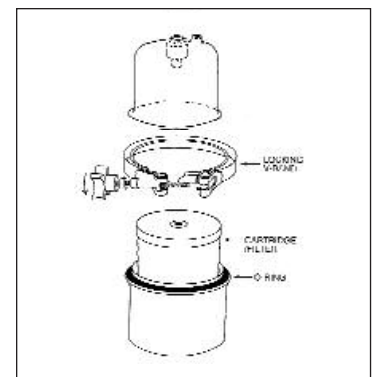
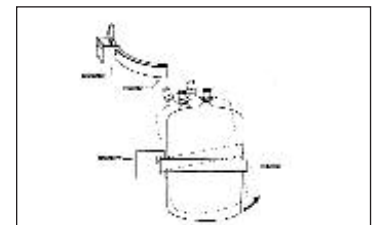
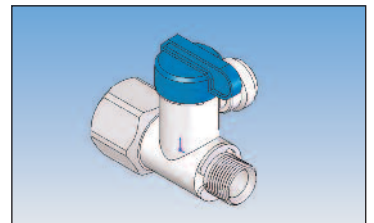

4.3: Installing the New Filter

1. If you have not done so already, remove the plastic wrapper and instruction wrap from around the new filter.
2. Align the threaded hole of the new filter cartridge onto the inside thread of the top half of the DWS. Rotate the cartridge clockwise to tighten (if facing the inside of the top half of the housing). Make sure that the cartridge is threaded properly and straight. **DO NOT OVERTIGHTEN.**
3. Reconnect the top half of the housing (with attached filter cartridge) with the bottom half. Replace the Locking V-Band, making sure the screw is in place to connect the band together.
4. Screw the black knob onto the Locking V-Band, turning it clockwise to tighten.
5. Make sure that the V-Band is tightly secured evenly around the housing top and bottom.
6. To resume normal use of the DWS, proceed to **3.7: Preparing and Operating Your Drinking Water System.**

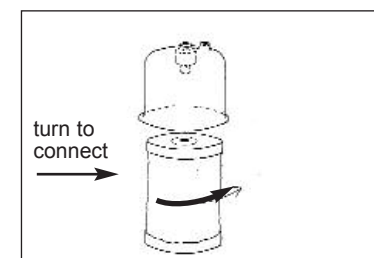
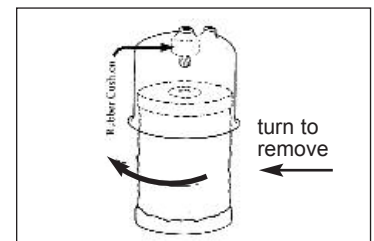

4.4: Resetting the Capacity Monitor or Changing the Batteries

Resetting the Capacity Monitor

After changing the drinking water system filter, the capacity monitor must be reset to its original capacity.

1. Press and hold the check/reset button on the Filter Monitor Unit (FMU) for three (3) seconds. You should hear a long audible sound.
2. The LED on the LED Display Plate will blink green for one (1) second with an audible sound, then blink green and red for one (1) second each, and then blink green five (5) times twice. The remaining capacity and time is now reset to the original capacity.

Changing the Batteries

1. Open the top of the Filter Monitor Unit and remove and discard the used batteries.
2. Insert two (2) fresh AAA batteries into the battery compartment, making sure to match the + and – signs. Close the battery compartment.
3. There will be a long audio sound, and the LED will blink green for two seconds, and then blink green five times.
4. After installing the batteries, press the check/reset button to confirm the LED is functioning.

4.5: Flushing / Disinfecting the System

Multipure recommends that you not allow water to sit in the system for extended periods of time without use. If a unit is left unused for more than 10 days, it may need to be flushed / disinfected before resuming normal use.

1. Remove the filter by following the directions in 4.2: *Removing the Old Filter*.
2. Add 5 to 7 drops of bleach to the bottom half of the system.
3. Reconnect the top half of the housing without a replacement filter installed.
4. Turn on the water supply and allow the system to fill up with the water/bleach solution.
 - a. Countertop Systems:
 - i. Turn on the faucet, and press the right button on the diverter valve to select the filtered water spout.
 - ii. Once water begins to flow, press the left button to stop the filtered water spout.
 - iii. Turn off the faucet, and let the system soak for at least 30 minutes.
 - b. Below-sink Systems:
 - i. Remove the faucet spout and place it in a container with one quart of water and bleach (5 drops of bleach per one quart of water).
 - ii. Allow the system and the faucet to soak for at least 30 minutes.
 - iii. Clean the inside of the faucet spout with pipe cleaners. You may also use a mild detergent, such as Soft Scrub®.
5. Flush and rinse the system.
 - a. Countertop Systems:
 - i. With the faucet off, press the right button on the diverter valve to select the filtered water spout.
 - ii. Let the water and bleach flush out of the system until the water flow stops.
 - iii. Open, clean, and rinse out the inside of the system housing.
 - iv. Follow the directions in 1.1: **Installing the Filter Cartridge (Universal)**.
 - v. Follow the directions in 2.2: **Preparing and Operating Your Drinking Water System**.
 - b. Below-sink Systems:
 - i. Disassemble the system housing and pour out the water/bleach solution. Clean and rinse out the inside of the system housing.
 - ii. Follow the directions in 4.3: **Installing the New Filter**.

5. Additional Information

5.1: Warranty

Multipure 90-Day Guarantee: Multipure is confident in the performance of its Drinking Water Systems (DWS). If you should find this Drinking Water System unsatisfactory, let us know within 90 days of purchase for a prompt exchange or refund.

Multipure Warranty: Multipure warrants to the original retail customer its DWS and components to be free of defects in material and workmanship for use under normal care, and will repair or replace any system at no charge (excluding transportation to Multipure Corporate Headquarters) to the customer during the warranty period. The DWS housing is warranted for a lifetime (provided the filter has been changed at least once per year); all exterior hoses and attachments to the DWS are also warranted for defects in material and workmanship for one (1) year.

Multipure Solid Carbon Block Filters are warranted for defects in material and workmanship for use under normal care. The capacity of the filter cartridge depends upon the amount of impurities in the water to be processed.

Except as otherwise expressly provided above, Multipure makes no warranties, express or implied, arising by law or otherwise, including without limitation the implied warranties of merchantability and fitness for a particular purpose, to any person. This limited warranty may not be altered, varied, or extended except by a written instrument executed by Multipure. The remedy of repair or replacement as provided under this limited warranty is exclusive. In no event shall Multipure be liable for any consequential or incidental damages to any person whether occasioned by negligence of the manufacturer, including without limitation damages of loss of use, cost of substitution, property damage, or other monetary loss.

Warranty is valid only if the DWS is operated within conditions listed herein. The warranty begins from the date of purchase.

5.2: Performance Certifications



Multipure Drinking Water Systems Product Performance Tested and Certified

Multipure Drinking Water Systems have been tested and certified by NSF International to comply with NSF/ANSI Standards 42 and 53 for the reduction of specific contaminants being considered as established or potential health hazards.

Standard 42, Aesthetic Effects

System tested and certified by NSF International against NSF/ANSI Standard 42 for the reduction of:

- Chloramine
- Chlorine taste and odor
- Nominal Particulate reduction, class I

Standard 53, Health Effects

System tested and certified by NSF International against NSF/ANSI Standard 53 for the reduction of:

- Asbestos
- Chlordane
- Cyst
- Lead
- Mercury
- MTBE
- PCB
- Toxaphene
- Turbidity
- Radon
- VOC (listed below)

Volatile Organic Chemicals (VOC) includes:

Disinfection By-Products

- chloropicrin
- haloacetonitriles (HAN):
 - bromochloroacetonitrile
 - dibromoacetonitrile
 - dichloroacetonitrile
 - trichloroacetonitrile
- haloketones (HK):
 - 1,1-dichloro-2-Propanone
 - 1,1-trichloro-2-Propanone
- trihalomethanes (THMs; TTHMs):
 - bromodichloromethane
 - bromoform
 - chloroform
 - dibromochloromethane
 - tribromoacetic acid

Chemicals

- benzene
- carbon tetrachloride
- chlorobenzene
- 1,2-dichloroethane
- 1,1-dichloroethylene
- cis-1,2-dichloroethylene
- 1,2-dichloropropane
- cis-1,3-dichloropropylene
- ethylbenzene
- hexachlorobutadiene
- hexachlorocyclopentadiene
- simazine
- styrene
- 1,1,2,2-tetrachloroethane
- tetrachloroethylene
- toluene
- trans-1,2-dichloroethylene
- 1,2,4-trichlorobenzene
- 1,1,1-trichloroethane
- 1,1,2-trichloroethane
- trichloroethylene
- xylenes (total)

Herbicides

- alachlor
- atrazine
- 2,4-D
- dinoseb
- pentachlorophenol
- 2,4,5-TP (silvex)

Pesticides

- carbofuran
- dibromochloropropane (DBCP)
- o-dichlorobenzene
- p-dichlorobenzene
- endrin
- ethylene dibromide (EDB)
- heptachlor
- heptachlor epoxide
- lindane
- methoxychlor

Claims of capacity are not applicable to contaminants reduced by mechanical filtration because of broad variations in the quality and quantity of physical matter in your drinking water.



Filter Model CB6

5.3: Performance Data Sheet

Performance Data Sheet



Multipure Drinking Water Systems have been tested and certified under NSF/ANSI Standard 53 as shown below. The concentration of the indicated substances in water entering the system was reduced to a concentration less than or equal to the permissible limit for water leaving the system, as specified in NSF/ANSI 53, Health Effects.



For Model Nos. MP750SC, MP750SB, MP750SI, MP1200EL

Substance	Percent Reduction ^{**}	Influent challenge concentration (mg/L unless specified)	Maximum permissible product water concentration (mg/L unless specified)
ALACHLOR*	>98%	0.05	0.001
ASBESTOS	>99.9%	10 ⁷ to 10 ⁸ fibers/L; fibers greater than 10 micrometers in length	99% reduction requirement
ATRAZINE*	>97%	0.1	0.003
BENZENE*	>99%	0.081	0.001
BROMODICHLOROMETHANE (TTHM)*	>99.8%	0.300 +/- 0.30	0.015
BROMOFORM (TTHM)*	>99.8%	0.300 +/- 0.30	0.015
CARBOFURAN (Furadan)*	>99%	0.19	0.001
CARBON TETRACHLORIDE*	98%	0.078	0.0018
CHLORDANE	>99.5%	0.04 +/-10%	0.002
CHLOROBENZENE (Monochlorobenzene)*	>99%	0.077	0.001
CHLOROPICRIN*	99%	0.015	0.0002
CHLOROFORM (TTHM)* (surrogate chemical)	>99.8%	0.300 +/- 0.30	0.015
Cryptosporidium (CYST)	99.95%	minimum 50,000/mL	99.95%
CYST (Giardia; Cryptosporidium; Entamoeba; Toxoplasma)	99.95%	minimum 50,000/mL	99.95%
2, 4-D*	98%	0.110	0.0017
DBCP (see Dibromochloropropane)*	>99%	0.052	0.00002
1,2-DCA (see 1,2-DICHLOROETHANE)*	95%	0.088	0.0048
1,1-DCE (see 1,1-DICHLOROETHYLENE)*	>99%	0.083	0.001
DIBROMOCHLOROMETHANE (TTHM; Chlorodibromomethane)*	>99.8%	0.300 +/- 0.30	0.015
DIBROMOCHLOROPROPANE (DBCP)*	>99%	0.052	0.00002
o-DICHLOROBENZENE (1,2 Dichlorobenzene)*	>99%	0.08	0.001
p-DICHLOROBENZENE (para-Dichlorobenzene)*	>98%	0.04	0.001
1,2-DICHLOROETHANE (1,2-DCA)*	95%	0.088	0.0048
1,1-DICHLOROETHYLENE (1,1-DCE)*	>99%	0.083	0.001
CIS-1,2-DICHLOROETHYLENE*	>99%	0.17	0.0005
TRANS-1,2- DICHLOROETHYLENE*	>99%	0.086	0.001
1,2-DICHLOROPROPANE (Propylene Dichloride)*	>99%	0.08	0.001
CIS-1,3- DICHLOROPROPYLENE*	>99%	0.079	0.001
DINOSEB*	99%	0.17	0.0002
EDB (see ETHYLENE DIBROMIDE)*	>99%	0.044	0.00002
ENDRIN*	99%	0.053	0.00059
Entamoeba (see CYSTS)	99.95%	minimum 50,000/mL	99.95%
ETHYLBENZENE*	>99%	0.088	0.001
ETHYLENE DIBROMIDE (EDB)*	>99%	0.044	0.00002
Furadan (see CARBOFURAN)*	>99%	0.19	0.001

****Percent reduction reflects actual performance of Multipure product as specifically tested (at 200% of capacity, i.e. 1500 gallons). Percent reduction shown for VOCs* reflects the allowable claims for Volatile Organic Chemicals/Compounds as per Tables. Chloroform was used as a surrogate for VOC reduction claims, the Multipure Systems' actual reduction rate of Chloroform was >99.8% as tested (at 200% of capacity).**

5.3: Performance Data Sheet (continued)

Substance	Percent Reduction**	Influent challenge concentration (mg/L unless specified)	Maximum permissible product water concentration (mg/L unless specified)
Giardia Lamblia (see CYST)	>99.95%	minimum 50,000/mL	99.95%
HALOACETONITRILES (HAN)*			
BROMOCHLOROACETONITRILE	98%	0.022	0.0005
DIBROMOACETONITRILE	98%	0.024	0.0006
DICHLOROACETONITRILE	98%	0.0096	0.0002
TRICHLOROACETONITRILE	98%	0.015	0.0003
HALOKETONES (HK):*			
1,1-DICHLORO-2-PROPANONE	99%	0.0072	0.0001
1,1,1-TRICHLORO-2-PROPANONE	96%	0.0082	0.0003
HEPTACHLOR*	>99%	0.25	0.00001
HEPTACHLOR EPOXIDE*	98%	0.0107	0.0002
HEXACHLORO BUTADIENE (Perchlorobutadiene)*	>98%	0.044	0.001
HEXACHLORO CYCLOPENTADIENE*	>99%	0.060	0.000002
LEAD (pH 6.5)	>99.3%	0.15 +/- 10%	0.010
LEAD (pH 8.5)	>99.3%	0.15 +/- 10%	0.010
LINDANE*	>99%	0.055	0.00001
MERCURY (pH 6.5)	>99%	0.006 +/- 10%	0.002
MERCURY (pH 8.5)	>99%	0.006 +/- 10%	0.002
METHOXYCHLOR*	>99%	0.050	0.0001
Methylbenzene (see TOLUENE)*	>99%	0.078	0.001
Monochlorobenzene (see CHLOROBENZENE)*	>99%	0.077	0.001
MTBE (methyl tert-butyl ether)	>96.6%	0.015 +/- 20%	0.005
POLYCHLORINATED BIPHENYLS (PCBs , Aroclor 1260)	>99.9%	0.01 +/- 10%	0.0005
PCE (see TETRACHLOROETHYLENE)*	>99%	0.081	0.001
PENTACHLOROPHENOL*	>99%	0.096	0.001
Perchlorobutadiene (see HEXACHLORO BUTADIENE)*	>98%	0.044	0.001
Propylene Dichloride (see 1,2-DICHLOROPROPANE)*	>99%	0.080	0.001
RADON	>94.9%	4000 ± 1000 pCi/L	300 pCi/L
SIMAZINE*	>97%	0.120	0.004
Silvex (see 2,4,5-TP)*	99%	0.270	0.0016
STYRENE (Vinylbenzene)*	>99%	0.15	0.0005
1,1,1-TCA (see 1,1,1-TRICHLOROETHANE)*	95%	0.084	0.0046
TCE (see TRICHLOROETHYLENE)*	>99%	0.180	0.0010
1,1,2- TETRACHLOROETHANE*	>99%	0.081	0.001
TETRACHLOROETHYLENE*	>99%	0.081	0.001
TOLUENE (Methylbenzene)*	>99%	0.078	0.001
TOXAPHENE	>92.9%	0.015 +/- 10%	0.003
Toxoplasma (see CYSTS)	99.95%	minimum 50,000/mL	99.95%
2,4,5-TP (Silvex)*	99%	0.270	0.0016
TRIBROMOACETIC ACID*	98%	0.042	0.001
1,2,4 TRICHLOROBENZENE (Unsymtrichlorobenzene)*	>99%	0.160	0.0005
1,1,1-TRICHLOROETHANE (1,1,1-TCA)*	95%	0.084	0.0046
1,1,2-TRICHLOROETHANE*	>99%	0.150	0.0005
TRICHLOROETHYLENE (TCE)*	>99%	0.180	0.0010
TRIHALOMETHANES (TTHM) (Chloroform; Bromoform; Bromodichloromethane; Dibromochloromethane)	>99.8%	0.300 +/- 0.30	0.015
TURBIDITY	>99%	11 +/- 1 NTU	0.5 NTU
Unsym-Trichlorobenzene (see 1,2,4-TRICHLOROBENZENE)*	>99%	0.160	0.0005
Vinylbenzene (see STYRENE)*	>99%	0.150	0.0005
XYLENES (TOTAL)*	>99%	0.070	0.001

5.3: Performance Data Sheet (continued)

NSF/ANSI 42 - Aesthetic Effects

The System has been tested according to NSF/ANSI Standard 42 for the reduction of the following substances. The concentration of the indicated substances in water entering the system was reduced to a concentration less than or equal to the permissible limit for water leaving the system.

Substance	Percent Reduction**	Influent challenge concentration (mg/L unless specified)	Maximum permissible product water concentration (mg/L unless specified)
CHLORAMINE as Aesthetic Effect (As Monochloramine)	>97%	3.0 mg/L +/- 10%	0.5 mg/L
CHLORINE as Aesthetic Effect	99%	2.0 Mg/L +/- 10%	> or = 50%
PARTICULATE , (Nominal Particulate Reduction, Class I, Particles 0.5 TO <1 UM)	Class I > 99%	At Least 10,000 particles/mL	> or = 85%

Note: This addresses the U.S. Environmental Protection Agency (EPA) Primary and Secondary Drinking Water Regulations in effect at its time of publication, as they relate to Multipure's performance in conformance to the industry performance criteria. These regulations are continually being updated at the Federal level. Accordingly, this list of MCLs will be reviewed and amended when appropriate. Please visit our website for list of product certifications.

NOTES:

- Multipure Drinking Water Systems have been certified, as indicated, by NSF International for compliance to NSF/ANSI Standard Nos. 42 & 53.
- The Multipure Drinking Water Systems have been certified by the State of California Department of Public Health for the reduction of specific contaminants listed herein.
- Chloroform was used as a surrogate for claims of reduction of VOCs. Multipure Systems tested at >99.8% actual reduction of Chloroform. Percent reduction shown herein reflects the allowable claims for VOCs as per tables in the Standard.
- Do not use with water that is microbiologically unsafe or of unknown quality without adequate disinfection before or after the system. Systems certified for cyst reduction may be used on disinfected water that may contain filterable cysts.**
- Filter life will vary in proportion to the amount of water used and the level of impurities in the water being processed. For optimum performance, it is essential that the filter be replaced on a regularly scheduled basis as follows: (a) annually; (b) when the unit's rated capacity has been reached; (c) the flow rate diminishes; or (d) the filter becomes saturated with bad tastes and odors.
- Multipure Drinking Water System Housings are warranted for a lifetime (provided that filter has been changed at least once per year). All exterior hoses and attachments to the System are warranted for one year. Please see the Owner's Manual for complete product guarantee and warranty information.
- Please see the Owner's Manual for installation instructions and operating procedures.
- In compliance with New York law, it is recommended that before purchasing a water treatment system, NY residents have their water supply tested to determine their actual water treatment needs. Please compare the capabilities of the Multipure unit with your actual water treatment needs.
- While testing was performed under standard laboratory conditions, actual performance may vary.
- The list of substances which the treatment device reduces does not necessarily mean that these substances are present in your tap water.

5.4: California Certification Department of Public Health

State of California
 Department of Public Health
 Water Treatment Device
 Certificate Number
 97 - 1294
 Date Issued: June 23, 2012

Trademark/Model Designation

MP750SB
 MP750SC
 MP750SI
 MPCT

Replacement Elements: CB6

Manufacturer: Multipure International

The water treatment device(s) listed on this certificate have met the testing requirements pursuant to Section 116830 of the Health and Safety Code for the following health related contaminants:

Microbiological Contaminants

Cysts (protozoan)
 Turbidity

Inorganic/Radiological Contaminants

Asbestos
 Lead
 Mercury
 Radon

Organic Contaminants

Chlordane
 PCBs
 Toxaphene
 MTBE
 VOCs

VOCs by Surrogate:
 Alachlor
 Atrazine
 Benzene
 Carbofuran
 Carbon Tetrachloride
 Chlorobenzene
 Chloropicrin
 2,4-D
 DBCP
 o-Dichlorobenzene
 p-Dichlorobenzene
 1,2-Dichloroethane
 1,1-Dichloroethylene
 cis-1,2-Dichloroethylene
 trans-1,2-Dichloroethylene
 1,2-Dichloropropane
 cis-1,3-Dichloropropylene
 Dinoseb
 Endrin
 Ethylbenzene
 EDB
 Haloacetoneitriles (HAN)
 Bromochloroacetoneitrile
 Dibromoacetoneitrile
 Dichloroacetoneitrile
 Trichloroacetoneitrile
 Haloketones (HK)
 1,1-Dichloro-2-Propanone
 1,1,1-Trichloro-2-Propanone
 Heptachlor
 Heptachlor Epoxide
 Hexachlorobutadiene
 Hexachlorocyclopentadiene
 Lindane
 Methoxychlor
 Pentachlorophenol
 Simazine
 Styrene
 1,1,2,2-Tetrachloroethane
 Tetrachloroethylene
 Toluene
 2,4,5-TP (Silvex)
 Tribromoacetic Acid
 1,2,4-Trichlorobenzene
 1,1,1-Trichloroethane
 1,1,2-Trichloroethane
 Trichloroethylene
 Trihalomethanes (THMs)
 Bromodichloromethane
 Bromoform
 Chloroform
 Chlorodibromomethane
 Xylenes

Rated Service Capacity: 750 gallons

Rated Service Flow: 0.75 gpm

Do not use where water is microbiologically unsafe or with water of unknown quality, except that systems claiming cyst reduction may be used on water containing cysts.

Do not use on water sources with a radon activity greater than 4000 pCi/L and follow the manufacturer's recommended replacement schedule for the carbon filter (to a maximum of one year). System treats radon from drinking water only and does not reduce radon from indoor air.

State of California
 Department of Public Health
 Water Treatment Device
 Certificate Number

97 - 1295

Date Issued: June 23, 2012

Trademark/Model Designation
 Multi-Pure MP1200EL

Replacement Elements: CB6

Manufacturer: Multipure International

The water treatment device(s) listed on this certificate have met the testing requirements pursuant to Section 116830 of the Health and Safety Code for the following health related contaminants:

Microbiological Contaminants

Cysts (protozoan)
 Turbidity

Inorganic/Radiological Contaminants

Asbestos
 Lead
 Mercury
 Radon

Organic Contaminants

Chlordane
 PCBs
 Toxaphene
 MTBE
 VOCs

VOCs by Surrogate:
 Alachlor
 Atrazine
 Benzene
 Carbofuran
 Carbon Tetrachloride
 Chlorobenzene
 Chloropicrin
 2,4-D
 DBCP
 o-Dichlorobenzene
 p-Dichlorobenzene
 1,2-Dichloroethane
 1,1-Dichloroethylene
 cis-1,2-Dichloroethylene
 trans-1,2-Dichloroethylene
 1,2-Dichloropropane
 cis-1,3-Dichloropropylene
 Dinoseb
 Endrin
 Ethylbenzene
 EDB
 Haloacetoneitriles (HAN)
 Bromochloroacetoneitrile
 Dibromoacetoneitrile
 Dichloroacetoneitrile
 Trichloroacetoneitrile
 Haloketones (HK)
 1,1-Dichloro-2-Propanone
 1,1,1-Trichloro-2-Propanone
 Heptachlor
 Heptachlor Epoxide
 Hexachlorobutadiene
 Hexachlorocyclopentadiene
 Lindane
 Methoxychlor
 Pentachlorophenol
 Simazine
 Styrene
 1,1,2,2-Tetrachloroethane
 Tetrachloroethylene
 Toluene
 2,4,5-TP (Silvex)
 Tribromoacetic Acid
 1,2,4-Trichlorobenzene
 1,1,1-Trichloroethane
 1,1,2-Trichloroethane
 Trichloroethylene
 Trihalomethanes (THMs)
 Bromodichloromethane
 Bromoform
 Chloroform
 Chlorodibromomethane
 Xylenes

Rated Service Capacity: 1200 gallons

Rated Service Flow: 0.75 gpm

Do not use where water is microbiologically unsafe or with water of unknown quality, except that systems claiming cyst reduction may be used on water containing cysts.

Do not use on water sources with a radon activity greater than 4000 pCi/L and follow the manufacturer's recommended replacement schedule for the carbon filter (to a maximum of one year). System treats radon from drinking water only and does not reduce radon from indoor air.

5.5: Troubleshooting

Issue	Solution
<p>Odor – rotten eggs, no discoloration on the filter</p>	<p>A rotten egg odor is a sign that H₂S (hydrogen sulfide) gas is present in your water source.</p> <p>If hydrogen sulfide gas is present in your water source, it is recommended that you rotate DWS usage between 2 filter cartridges. When the DWS emits the rotten egg smell, remove the filter and allow it to dry upside down to allow the gas to dissipate (the filter can be reused once dry). Use the second filter in the unit while the first filter is drying.</p>
<p>Odor – rotten eggs, with discoloration on the filter</p>	<p>A rotten egg odor is a sign that H₂S (hydrogen sulfide) is present in your water source. Filter discoloration can determine the source:</p> <ul style="list-style-type: none"> • orange/brownish colors – iron • blackish colors – manganese • slimy/blotchy colors – decaying organisms <p>When hydrogen sulfide comes from a source that discolors the filter cartridge and creates a strong rotten egg odor, the only recommended solution is to change the filter cartridge.</p>
<p>Color – milky color in the water</p>	<p>Milky color in the water is typically caused by air bubbles in the water. Higher than normal water pressure through the DWS can create these small air bubbles, but they do not affect system performance. Air in the water may also be the result of conditions in your municipal water supply.</p> <p>For countertop systems, turn on the water and engage the diverter valve while slightly reducing the water flow. Less water pressure through the system can prevent air bubbles from forming.</p>
<p>Color – black color in the water</p>	<p>Black color in the water is typically caused by residual carbon dust from the filter.</p> <p>Allow water to run through the DWS for approximately 30 minutes to flush the filter. Residual carbon dust may initially color the water black.</p>
<p>Flow rate – the water flow rate is slow</p>	<p>The filter is designed to restrict its flow rate when clogged with particulates or other solid contaminants.</p> <p>When the water flow rate slows to the point of inconvenience, it is time to replace the filter cartridge. If other water sources are on while using the DWS, turn them off to check if they are affecting the flow rate.</p>
<p>Taste/Odor – miscellaneous</p>	<p>The carbon block filter may have become saturated with the tastes and odors treated in your drinking water.</p> <p>To resolve this, change the filter.</p>
<p>Bypass lever – sticking (hard to move)</p>	<p>Minerals in the water can build up on the diverter valve, causing the bypass lever to stick and preventing the buttons from being pressed easily.</p> <p>A sticking bypass lever can be solved by lubricating it or by dissolving the mineral deposits.</p> <p><u>Lubrication</u> – requires vegetable oil; because lubrication does not dissolve the mineral deposits, it may need to be performed periodically.</p> <ol style="list-style-type: none"> 1. Unscrew the diverter valve and remove from the faucet. 2. Pour a small amount of vegetable oil in the inlet hole. 3. Push the left and right buttons on the diverter valve several times to lubricate it thoroughly. 4. Reconnect the diverter valve to the faucet. <p><u>Dissolving</u> – requires vinegar; may cause discoloration to the metal.</p> <ol style="list-style-type: none"> 1. Unscrew the diverter valve and remove from the faucet. 2. Soak the diverter valve in a bowl of vinegar for 10 minutes. 3. Rinse the diverter valve and reconnect to the faucet.
<p>Bypass lever – stuck (cannot be pressed)</p>	<p>The bypass lever can occasionally become stuck due to the presence of air in the tubing. This can prevent the buttons from being pressed.</p> <ol style="list-style-type: none"> 1. Unscrew the diverter valve and remove from the faucet. 2. Press the left and right buttons to test it. If they press in easily, then removing the diverter valve freed the air in the tubing. 3. Reconnect the diverter valve to the faucet.

5.6: Frequently Asked Questions

Question	Answer
Will low pH or acidic water affect the filter?	<p>No. Mineral components can determine the pH of water, and minerals dissolved in solution in the water pass through the system unfiltered.</p> <ul style="list-style-type: none"> • pH 7 = neutral • pH > 7 = alkaline • pH < 7 = acidic
Does deionized water or soft water have an effect on Multipure water?	No. Because Multipure filters do not treat the natural minerals dissolved in water, the hardness or softness of water has no effect on the resultant filtered Multipure water.
Can the Multipure system be connected to an icemaker?	The Aquaversa countertop cannot be connected to an icemaker, although Multipure below sink Drinking Water Systems (Aquaversa, Aquaperform) can be connected to the sink, refrigerator, water dispenser, or icemaker.
Can the Multipure system be used during an emergency or when the water is turned off?	<p>Yes. During an emergency or when the source water is off, you can hand pump or siphon water through the Multipure system.</p> <p>CAUTION: The Multipure system is not intended for use where the water is microbiologically unsafe or with water of unknown quality without adequate disinfection before or after the unit. To disinfect questionable source water, add 1/4 tsp. of household bleach per gallon of source water; the Multipure system will remove this solution from the water during the filtering process. Hand pump kits and emergency kits are available from Multipure.</p>
What causes white particles to appear in Multipure water when it is frozen or boiled?	<p>Because the Aquaversa does not reduce any natural minerals present in water, these minerals may solidify when the water is frozen and appear as white flakes or specks when the water is melted or boiled.</p> <p>Many natural minerals in water are beneficial to your health, and their existence in drinking water (in normal quantities) is not cause for alarm. Minerals can be removed by Reverse Osmosis technology, which is available through the Multipure AquaRO Drinking Water System.</p>
Why does the Multipure system reduce Volatile Organic Chemicals, but not natural minerals?	Minerals are dissolved in solution and do not have an actual physical size; thus, the minerals pass through the system unfiltered.
Should sediment be removed with a standard filter first?	<p>In areas with excessive sedimentation, pre-filtration can help extend the operational efficiency of the Multipure filter; however, in most areas it is unnecessary.</p> <p>Multipure Drinking Water Systems utilize a double-filter mechanic. The outer material is a pre-filter that protects the solid carbon block from prematurely clogging with large sediment.</p>
Why is the compressed solid carbon block filter more efficient than (loose) granular activated carbon filters?	Multipure's densely compacted solid carbon block filters force water through microscopic pores of carbon – much smaller than those of granular activated carbon – thus more effectively reducing particulate matter and contaminants that affect the taste and odor of the water.
What is the difference between a “water softener” and a Multipure Drinking Water System?	<p>Water softeners are not designed to treat drinking water for contaminants; instead, they are designed to adjust the hardness (mineral content) of the water.</p> <p>Soft water is often desirable for bathing and laundering purposes, and may extend the life of hot water heaters and boilers. However, soft water is not recommended for use on plants or lawns. Multipure recommends that you bypass a water softener when installing your Multipure Drinking Water System.</p>
Can the Multipure Drinking Water System be used with untreated water?	<p>Questionable water sources should be disinfected prior to use. To disinfect questionable source water, add 1/4 tsp of household bleach per gallon of source water; the Multipure system will remove this solution from the water during the filtering process.</p> <p>Multipure systems are designed to be used with municipally treated water; they are not intended to be used where the water is microbiologically unsafe or with water of unknown quality without adequate disinfection before or after the unit. Systems certified for cyst reduction may be used on disinfected waters that may contain filterable cysts.</p>

Be sure to replace your filter at least once a year or sooner, if needed.

Date of Installation: _____
Unit Model Number: _____
Filter Type: _____
Dates of Filter Change

To order a Replacement Filter

Call 800.622.9208

or

www.multipure.com/rf.htm



Multipure

7251 Cathedral Rock Drive

Las Vegas, NV 89128

800.622.9206 toll-free

702.360.8880 phone

702.360.8575 fax

headquarters@multipure.com